

OPERATION MANUAL

LONG TUBE LLG-pH Pen



CE

Model: 6.263 690

INTRODUCTION

Congratulations on your purchase of this pen type long probe pH meter. Please read the manual completely before using this meter. Filing and keeping the manual for future reference. Recommended to soak the electrode for at least 30 minutes before using to clear up the memory and possible contamination effect or to make the electrode wet if the pH electrode dries out.

Features:

- **IP65 Waterproof** housing.
- **Dual display** with ATC.
- **Data hold** to freeze readings.
- **Compact size**, easy to fit in pocket.
- **Low battery** indicator.
- **Auto power off**.
- **C/F** unit switchable.
- Power by 2pcs **CR2032** batteries.
- **Multi points** calibration.
- **One touch** only for calibration.

MATERIAL SUPPLIED

This package contains:

- ✓ pH-meter LLG-pH-Pen x 1
- ✓ CR2032 button battery x 2
- ✓ Operation manual

POWER SUPPLY

The meter is powered by 2 pcs CR2032 batteries. To check the battery when:

1. First time use
2. The battery symbol appears on LCD
3. The meter can not power on

To install the batteries:

1. Turn off the meter.
2. Loosen the battery cover in clockwise direction by coin (DON'T discard the black washer!)
3. Replace the old batteries with two new button cells CR2032.
4. Make sure the batteries are in place and the polarity is correct.
5. Put back the battery cover and turn it in counter-clockwise direction to lock

NOTE:

1. **Please re-calibrate the meters after changing batteries.**
2. **Remove battery from instruments that you do not plan to use for a month or more. Do not leave battery in instrument.**

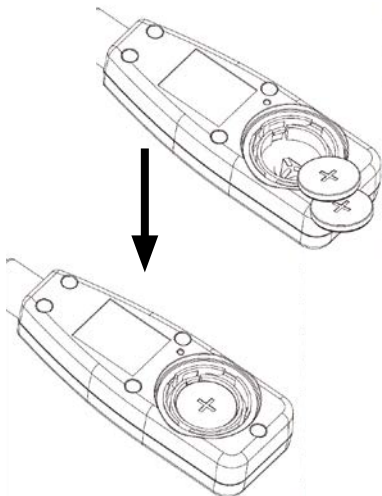

LCD DISPLAY

6.263 690

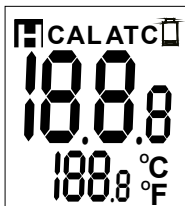

- The 1st display shows the measured pH reading.
- The 2nd display shows the temp.
- Cal = Calibration mode
- ATC = Auto Temp. Compensation
-  = Data hold

KEYPAD



OPERATION

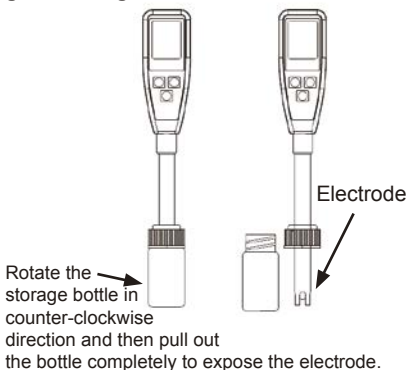

1. Remove the pH-meter from the probe storage bottle to expose the electrode out. It is normal if white crystals are present on the cap or electrode assembly.

WARNING: Please always make sure that the bottle is filled with storage buffer to keep the electrode wet and in good storage conditions.

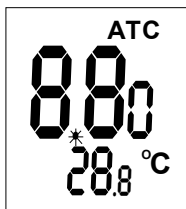

2. Dip the electrode into the test solution. Press “” to power on the meter and stir it to get a stable reading.
3. A small dot “•” is flashing while the meter is in measurement mode. The LCD not only shows the measured pH value but also displays the temperature.



4. Press “” to freeze current readings. The “” icon will appear on the LCD and the small dot will not flash. Press “” again to release the hold mode.

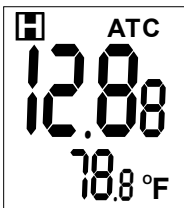



5. Turn off the meter by pressing “” button.
6. Once finishing the measurement, clean the electrode, put back the bottle, store the meter between 0~50 °C.
7. Please see page 8 for the calibration procedures.

AUTO POWER OFF (SLEEP FUNCTION)

This meter will shut off automatically 20 minutes of inactivity. For operating longer time, you can disable the sleep mode.

To disable the auto power off:

Before power on, pressing “” + “” keys simultaneously until a “n” appeared on the screen and then release keys to return to normal mode.

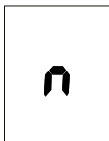





Note: The disable sleep mode will be invalid after every power off.

AUTOMATIC TEMPERATURE COMPENSATION (ATC) & TEMP. UNIT SETTING

The LLG-pH-Pen is capable of measuring with Automatic Temperature Compensation. “**ATC**” will be displayed in the middle top of the LCD.

Temp. Unit Setting of pH-pen

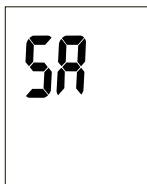
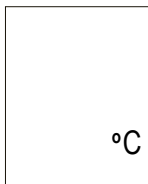

To select the temp. unit ($^{\circ}\text{C}$ or $^{\circ}\text{F}$), turn off the meter first. When the meter is off, press “” and “” at the same time until the C or F appears on the LCD. Press “” to select the preferred unit and then press “” to save. “SR” will appear on the LCD for one sec and then go back to normal.



CALIBRATION MODE (CAL)

Calibration is necessary and should be done regularly, recommended everyday if the meter is used often. The unique calibration design of the meter features automatic buffer recognition to avoid errors.

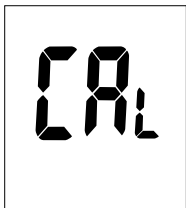
Calibration

1. Power on the meter.
2. Place the electrode into a buffer solution (4,7 or 10), pH7 should be calibrated first and then 4 or 10 pH for better accuracy
3. Press “

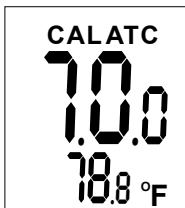

4. If probe or buffer is in error:
If the buffer is incorrectly inserted or the probe is damaged or the probe cannot detect buffer in below voltage range, the meter will escape calibration mode automatically after 10 seconds. Text “End” will appear on the LCD in one second and then will go back to normal status.

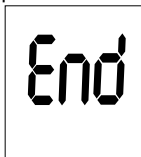

Acceptable voltage range of each point:

pH 4.00 : 97 mV..... 250 mV

pH 7.00 : - 60 mV..... 60 mV

pH10.00 : - 250 mV..... -97 mV

5. If the probe recognizes the buffer:
If the probe successfully recognizes the buffer, the buffer pH value (4 or 7 or 10) will appear on the display in 2 seconds.

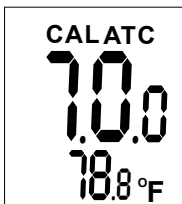

If the calibration buffer is not 4,7,10 but another value, such as 7.01, just press "▲
HOLD" to change the value.

6. The adjustable cal. point range for 4.0 pH is from 3.50 to 4.50. For 7.0 pH is from 6.50 to 7.50. For 10.0 pH is from 9.50 to 10.50
7. To save the calibration value:
When the electrode reads a stable value and user stops pressing any keys, the meter will automatically save the value and then escape the calibration mode.

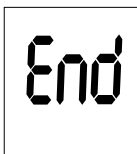

8. Rinse the probe with de-ionized water or a rinse solution (tap water...) after each measurement to last the meter's life.
9. Repeat above steps until the 3 point calibration are finished.

MAINTENANCE

- ✓ Please always keep the pH glass bulb wet by using the storage bottle to protect and store the electrode.
- ✓ Always rinse the pH electrode in de-ionized water or rinse solution (tap water.....) before next use.
- ✓ Never touch or rub glass bulb in order to last pH electrode life.
- ✓ Make sure the electrode is clean. Between measurements, rinse the electrode with deionised water. If the electrode has been exposed to a solvent immiscible with water, clean it with a solvent miscible with water e.g. ethanol or acetone and rinse carefully with water.
- ✓ Store the electrode carefully.

TROUBLESHOOTING

▶ Power on but no display

- 1) Make sure the time of pressing power key is more than 100 mS.
- 2) Check the battery are in place and make good contact and correct polarity.
- 3) Replace with new batteries and try again.
- 4) Move away the batteries for one minute and then put back again.

▶ Slow response

Clean probe by immersing the electrode in tap water for 10-15 minutes, then rinse thoroughly with distilled water or use a general purpose electrode cleaner.

▶ LCD display “ - - - ”

Out of pH range, too acidic/or too alkaline.

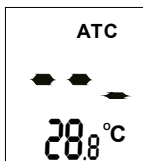

▶ “H.” Or “L.”

Out of temp. range, too cold/or too hot.

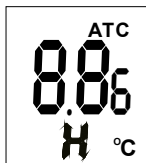

▶ pH value fluctuate quickly

It is normal when the electrode is not immersed in the water but exposed in air.

SPECIFICATION

LLG-pH Pen 6.263 690

SPECIFICATIONS	
Accuracy \pm	0.1 pH
Cal.Point (4.7.10)	●
Auto Power Off	●
Measurement range	0.00 - 14.00
Temp. Accuracy	± 1.0 °C
Temp. Resolution	0.5 °C / °F
Resolution	0,01 pH
Hold Data	●
Unit C/F switchable	●
ATC (0~50 °C)	●
Self-Calibration	●
Waterproof (IP65)	●
Size	210 (L) x 36 mm (W) x 20 mm (T)

- ✓ Operating Temp.: 0~50 °C (32~122 °F)
- ✓ Operating Humidity: 0~80 % RH
- ✓ pH calibration buffer suggested:
 - Standard USA buffers
 - Standard NIST buffers
 - Standard DIN buffers
- ✓ Battery Life: >100 hrs continuous use

WARRANTY

The meter is warranted to be free from defects in material and workmanship for a period of one year from the date of purchase. This warranty covers normal operation but does not cover battery, misuse, abuse, alteration, tampering, neglect, improper maintenance, or damage resulting from leaking batteries. Proof of purchase is required for warranty repairs . Warranty is void if the meter used to be taken apart.

RETURN AUTHORIZATION

Authorization must be obtained from the supplier before returning items for any reason. When requiring a RA (Return Authorization), please include data regarding the defective reason, the meters are to be returned along with good packing to prevent any damage in shipment and insured against possible damage or loss.



Lab Logistics Group GmbH

Am Hambuch 1

D-53340 Meckenheim

Tel.: +49 (0)2225 9211-0

Fax: +49 (0)2225 9211-11

www.llg-labware.com

info@llg-labware.com