

Analog Rotator uniLOOPMIX and uniROTATOR



User Manual



LLG-uniROTATOR 2

6.263 660

LLG-uniLOOPMIX 2

6.263 665



Please read carefully before use, and follow all operating and safety instructions!

The design and specifications are subject to change without prior notice.

Contents

Preface	1
Service	1
Warranty.....	1
1. Safety Instructions.....	2
2. Proper Use.....	3
3. Inspection	3
3.1 Receiving Inspection	3
3.2 Listing of Items	3
4. Control.....	4
5. Installation	5
6. Operation	6
7. Maintenance and Cleaning.....	6
8. Associated standards and regulations	7
9. Specification	8
10. Ordering Information.....	8
11. Accessories	9

Preface

Welcome to the “Rotator User Manual”. Users should read this manual carefully, follow the instructions and procedures, and beware of all the cautions when using this instrument.

Service

When help needed, you can always contact the service department of manufacturer for technical support in the following ways:

Lab Logistics Group GmbH

Am Hambuch 1

D-53340 Meckenheim

Telefon: +49 (0)2225 - 92 11-0

Telefax: +49 (0)2225 - 92 11-11

E-mail: info@llg.de

www.llg.de

Please provide the customer care representative with the following information:

- Serial number (on the rear panel)
- Certification
- Description of problem (i.e., hardware or software)
- Methods and procedures adopted to resolve the problems
- Your contact information

Warranty

This instrument is warranted to be free from defects in materials and workmanship under normal use and service, for a period of 36 months from the date of invoice. The warranty is extended only to the original purchaser. It shall not apply to any product or parts which have been damaged on account of improper installation, improper connections, misuse, accident or abnormal conditions of operation.

For claims under the warranty please contact your local supplier. You may also send the instrument directly to manufacturer, enclosing the invoice copy and by giving reasons for the claim.

1. Safety Instructions



Warning!

- Read the operating instructions carefully before use.
- Ensure that only trained staff works with the instrument.



Protective ground contact!

- Ensure the socket must be grounded (protective ground contact) before use.

- When working wear personal safety guards to avoid the risk of:
 - Splashing liquids
 - Broken glass containers
- Follow the safety instructions, guidelines and accident prevention regulations.
- Do not touch the running parts, moving instrument care not rolling your fingers.
- Set up the instrument in a spacious area on a stable, clean, non-slip, dry and fireproof surface. Do not operate the instrument in explosive atmospheres, with hazardous substances or

under water.

- If the instrument does not run smoothly, please decrease the motor speed.
- Firmly secure the accessories and vessels in place to avoid damage or risk.
- Preparation of samples may lead to dangerous flammable. Only process samples that will not react dangerous.
- Use the standard accessories listed in the “accessories” section, and follow the instructions to use accessories to ensure safety. Please switch off the power before assembly of accessories, confirm the instrument and accessories are intact before switch on each time.
- The instrument only be opened by expert, please switch off before use.
- The voltage stated on the nameplate must correspond to the mains voltage.
- Do not cover the instrument during running. Prevent the collision and extrusion to instrument and accessories.
- Keep away from high magnetic field.

2. Proper Use

The instrument is designed for mixing viscous substances in schools, laboratories or factories. It can be installed on a variety of impeller, for different viscosity of the medium.

Do not use the accessories recommended by the manufacturer, or failure to use the instructions, may be caused unsafe situation.

3. Inspection

3.1 Receiving Inspection

Unpack the instrument carefully and check for any damages which may have arisen during transport. If it happens, please contact manufacturer/supplier for technical support.



Note:

If there is any apparent damage to the system, please do not connect to the power line.

3.2 Listing of Items

Items	Qty
Main unit	1
Power cable	1
User manual	1

4. Control

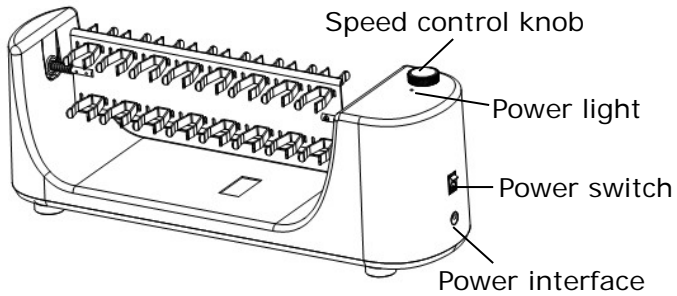

Figure 1

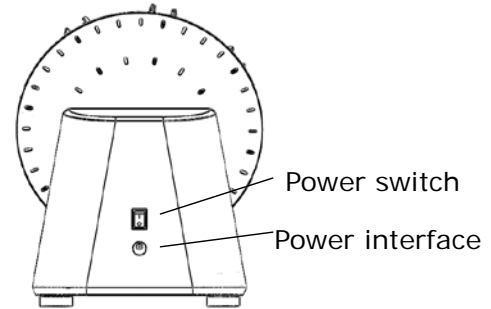

Figure 3

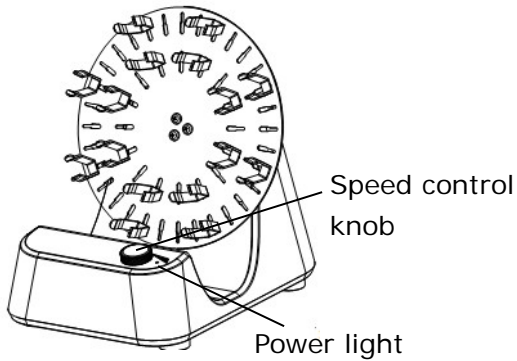

Figure 2

Items	Descriptions
Speed control knob	Set target speed.
Power switch	Switch ON/OFF instrument.
Power interface	Connect the power cable
Power light	Green LED display light

5. Installation

- Install the accessory according following instruction
- Hold the two wings of the clamp, place the hook head in the wide side of the hole, and snap it into the narrow end.

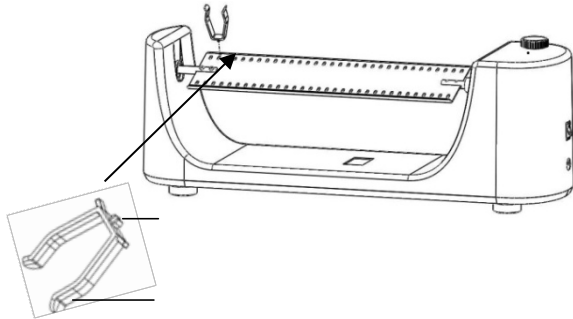

Figure 4

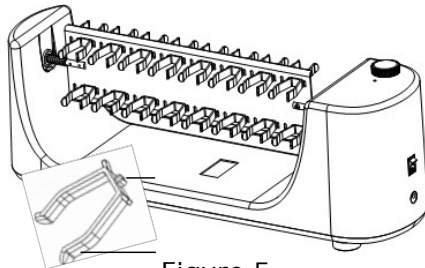

Figure 5

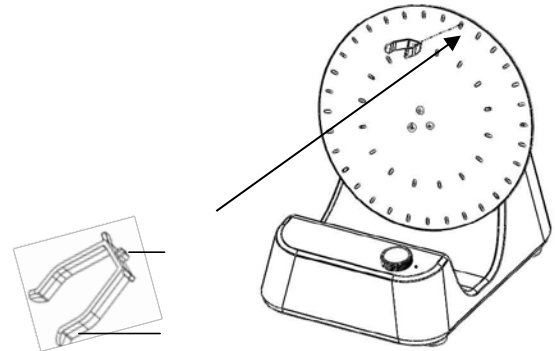

Figure 6

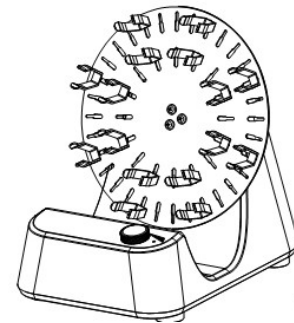

Figure 7

6. Operation

- Place the instrument in safe and stable surface, ensure the required operating voltage and power supply voltage matched, and the socket must be earthed reliably.
- Connect the power cable.
- Install the platform.
- Switch ON the instrument.
- Rotate the speed control knob clockwise to set target speed, and the shaking function will be switched on.
- Rotate the speed control knob to the left-most position to switch off the shaking function.
- Switch OFF the instrument.
- If these operations above are normal, the instrument is ready to operate. If not, the instrument may be damaged during transportation, please contact technical support of manufacturer/supplier.



Note:

The speed value can be altered during shaking.

7. Maintenance and Cleaning

- Proper maintenance can keep instrument working properly and lengthen its lifetime.
- Do not spray cleanser into the instrument when cleaning.
- Please remove the power line when cleaning.

Only use recommended cleansers:

Dyes	Isopropyl alcohol
Construction materials	Water containing tenside / Isopropyl alcohol
Cosmetics	Water containing tenside / Isopropyl alcohol
Foodstuffs	Water containing tenside
Fuels	Water containing tenside

- Before using other method for cleaning or decontamination, the user must ascertain with the manufacturer that this method will not damage the instrument. Wear the proper protective gloves during cleaning of the instrument.

**Note:**

- Electronic device cannot clean with cleanser.
- If you require maintenance service, must be cleaned the instrument in advance to avoid pollution of hazardous substances, and to send back into original packing.
- If the instrument will not use for a long time, please switch off and place in a dry, clean, room temperature and stable location.

8. Associated standards and regulations

Construction in accordance with the following safety standards:

EN 61010-1

UL 3101-1

CAN/CSA C22.2(1010-1)

EN 61010-2-10

Construction in accordance with the following EMC standards:

EN 61326-1

Changes or modifications not expressly approved by the party responsible for compliance could void the user's authority to operate the equipment.

NOTE: This equipment has been tested and found to comply with the limits for a Class A digital device, pursuant to Part 15 of the FCC Rules. These limits are designed to provide reasonable protection against harmful interference when the equipment is operated in a commercial environment. This equipment generates, uses, and can radiate radio frequency energy and, if not installed and used in accordance with the instruction manual, may cause harmful interference to radio communications. Operation of this equipment in a residential area is likely to cause harmful interference in which case the user will be required to correct the interference at his own expense.

9. Specification

Items	Specifications
P/N	6.263 660; 6.263 665
Voltage [VAC]	100-240
Frequency [Hz]	50/60
Motor rating input[W]	16
Motor rating output[W]	10
Motor type	DC motor
Speed range [rpm]	0-80
Shaking motion	Orbital
Dimensions [D×W×H mm]	300×220×310/ 150×530×190
Weight[kg]	2.0/1.7
Permissible ambient temperature [°C]	5-40
Permissible relative humidity	80 %
Protection class acc.DIN EN60529	IP21

10. Ordering Information

Cat. No.	Descriptions
6.263 660	LLG-uni <i>ROTATOR</i> 2, Analog Rotator, used with disk accessories, variable speed, EU plug, 100V-240V, 50Hz/60Hz
6.263 661	LLG-uni <i>ROTATOR</i> 2, Analog Rotator, used with disk accessories, variable speed, UK plug, 100V-240V, 50Hz/60Hz
6.263 665	LLG-uni <i>LOOPMIX</i> 2, Analog Rotator, used with rotisserie accessories, variable speed, EU plug, 100V-240V, 50Hz/60Hz
6.263 666	LLG-uni <i>LOOPMIX</i> 2 Analog Rotator, used with rotisserie accessories, variable speed, UK plug, 100V-240V, 50Hz/60Hz

11. Accessories

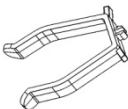
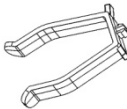
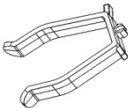
	Cat. No	Descriptions
	6.263 662	Clamp for 1.5ml centrifuge tube, Pack of 12.
	6.263 663	Clamp for 15ml centrifuge tube, Pack of 12
	6.263 664	Clamp for 50ml centrifuge tube, Pack of 12



Lab Logistics Group GmbH

Am Hambuch 1

D-53340 Meckenheim

Tel. +49 2225 9211-0

Fax + 49 2225 9211-11

www.llg-labware.com

info@llg-labware.com

